

# 東莞永力電業有限公司

YUNG LI CO., LTD

Da Pu Industrial Zone, Gang Zi, Changping Town,  
Dong Guan City, Guangdong 523571 China.P.R.C

TEL:0769-83396797~8

FAX:0769-83396796

E-mail: sales@yung-li.com

Description: YP-32/YC-20

Customer: SIGNAL+POWER

Parts No. :

Draw No. :

## REVISION RECORD

1		
2		
3		
4		
5		

YUNG LI		CUSTOMER	APPROVED
CHECKED	PREPARED BY		

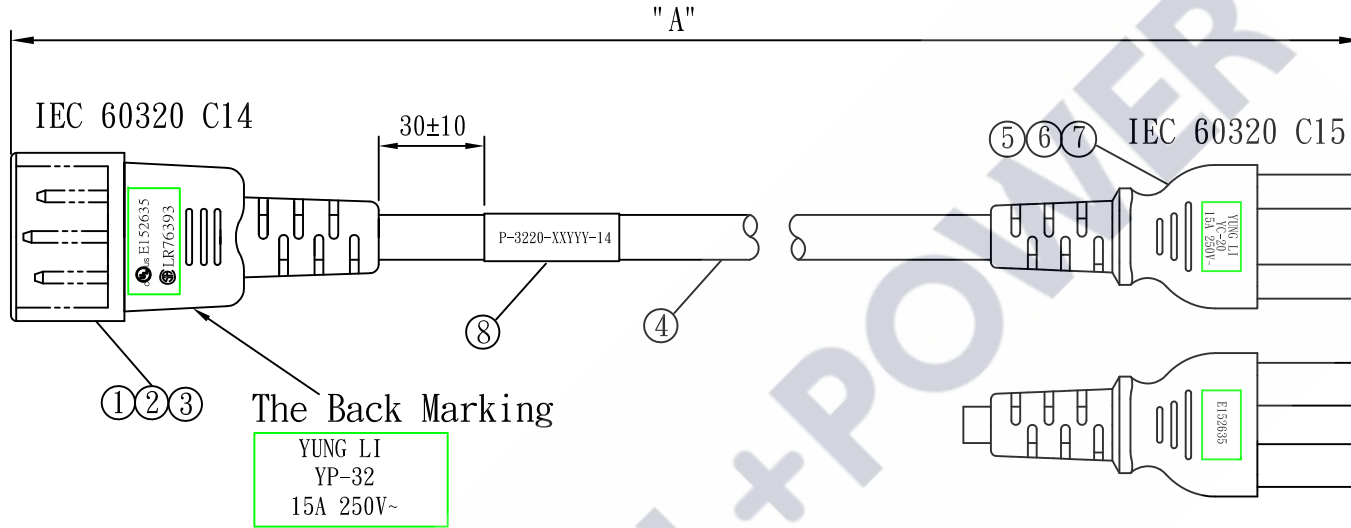
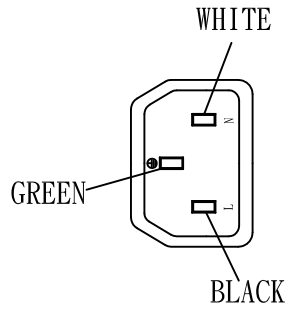

LENGTH: "A"	3FT	6FT	6.56FT	10FT
	915±30	1830±50	2000±50	3050±50
P/N WHITE(RAL9010)	P-3220-03WHT-14	P-3220-06WHT-14	P-3220-066WHT-14	P-3220-10WHT-14
P/N RED(GY-49)	P-3220-03RED-14	P-3220-06RED-14	P-3220-066RED-14	P-3220-10RED-14
P/N BLUE(PT293C)	P-3220-03BLU-14	P-3220-06BLU-14	P-3220-066BLU-14	P-3220-10BLU-14
P/N BLACK	P-3220-03BLK-14	P-3220-06BLK-14	P-3220-066BLK-14	P-3220-10BLK-14

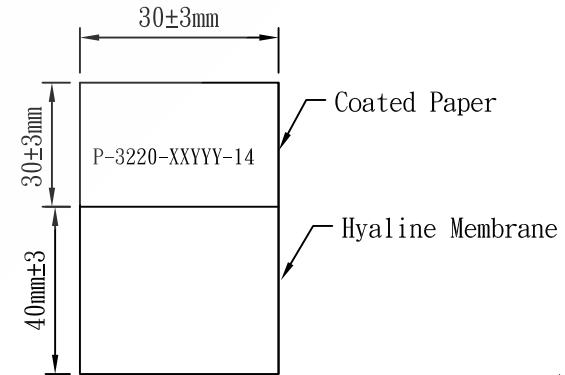

Sample Drawing No.:  
SP211018-06

Packing: Bundled to ease installation.

NO.	SPECIFICATION	QTY	REMARK
1	YP-32 PVC PLASTIC:50P	15g/PC	
2	TERMINAL:98672BS-1	3PCS	
3	H. S. G: 2X4	1PC	
4	SJT 14/3C 105°C	1PC	
5	YC-20 PVC PLASTIC 50P	18g/PC	
6	U-TYPE TERMINAL:97740	3PCS	
7	YC-20 INNER BODY	1PC	
8	LABEL:(30+40)*30mm	1PC	

Tolerance >0±0.30 >1.0±0.50 >10.0±1.0 >20.0±2.0 Angle: ±1°	Approved	Date		SIGNAL+POWER				
	Checked	Date						
	Drawn	SUKI	Date	21.11.03	Customer			
	Cat. No.	YP-32/YC-20			P/N.	P-3220-XXYYY-14		
	Drawing No.	Rev.	B	Material	P. V. C	Unit	mm	
			Scale					

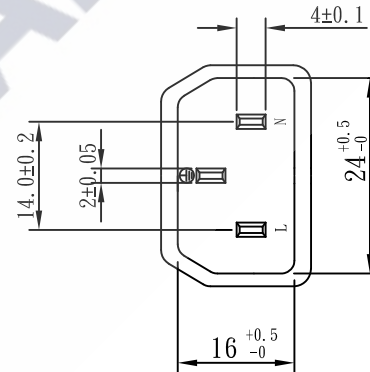
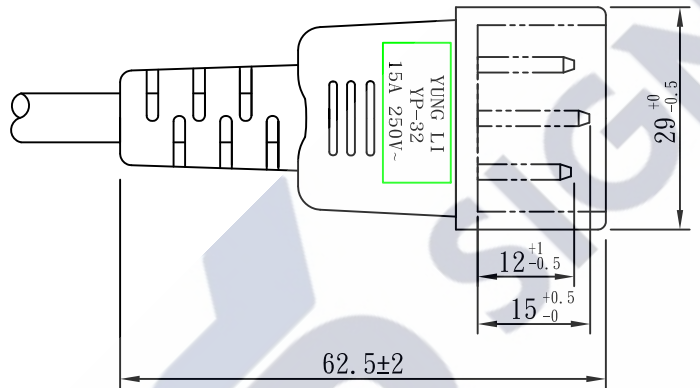
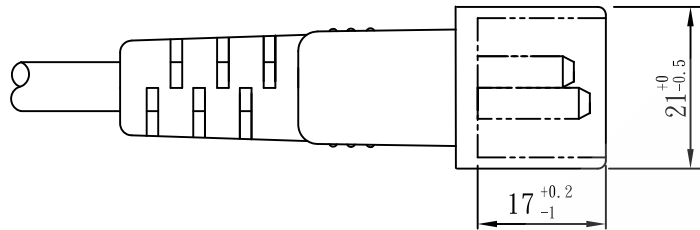
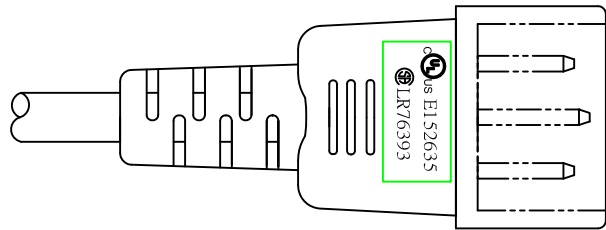

TOLERANCE >0±0.30 >1.0±0.50 >10.0±1.0 >20.0±2.0 Angle: ±1°	APPROVED		DATE		YUNG LI CO., LTD			
	CHECKED		DATE					
	DRAWN	MELON	DATE	19.04.08	CUSTOMER			
	TYPE	YP-32			P/N			
	DRAWING NO.	CY-P32U15A	REV	B	MATERIAL	P. V. C	UNIT	mm
				SCALE	1:1			

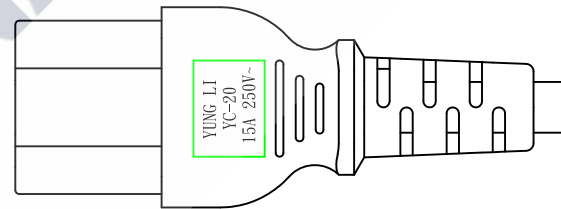
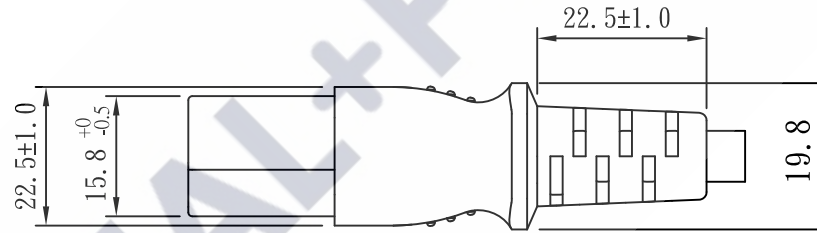
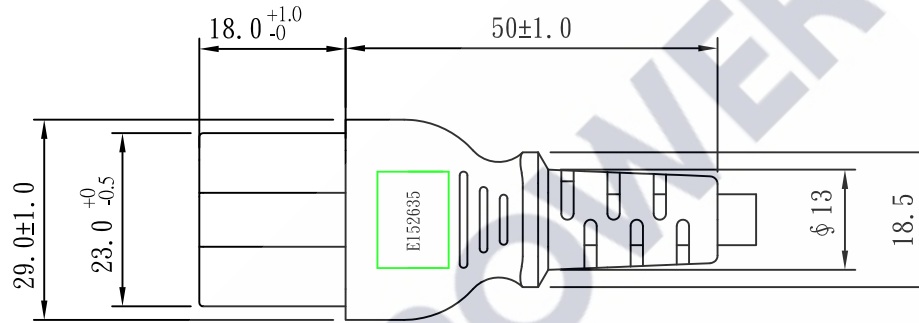
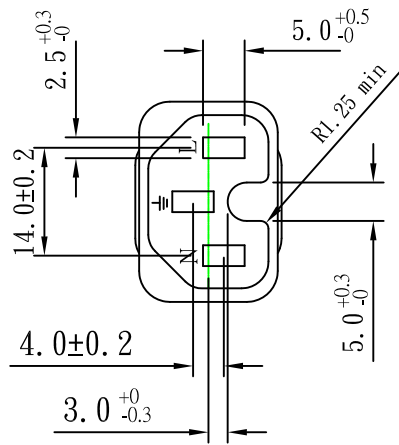

TOLERANCE >0±0.30 >1.0±0.50 >10.0±1.0 >20.0±2.0 Angle: ±1°	APPROVED		DATE		YUNG LI CO., LTD.			
	CHECKED		DATE					
	DRAWN		DATE		CUSTOMER			
	TYPE	YC-20			P/N			
	DRAWING NO.		REV	B	MATERIAL	P. V. C	UNIT	mm
				SCALE	1:1			

# YUNG LI CO., LTD

## SPECIFICATION

Yung-Li	Style	PVC FLEXIBLE CORDS	Document No
2017.09.28			
Edition	Size	<b>SJT 14/ 3C 105°C</b>	Page
A			1/2

1. Standard : UL 62 UL 1581

### 2. Construction & Dimension

	Item	Specification
Conductor	Size	14AWG X 3C
	Material	Annealed Bare Copper
	Construction	41/ $\phi$ 0.254 $\pm$ 0.003
Insulation	Material	PVC
	Minimum Average Thickness	0.76mm
	Minimum Thickness at any point	0.69mm
	Diameter	3.5 $\pm$ 0.10
	Identification	Black White Green
Core Assembly	Core Twist	3-Core
	Filler	NA
	Assembly Pair	NA
Taping	Mylar Foil	NA
Shielded	A1-Mylar Foil	NA
Drain Wire	Material	NA
	Construction	NA
Jacket	Material	PVC
	Minimum Average Thickness	0.76mm
	Minimum Thickness at any point	0.61mm
	Overall Diameter(Approx)	9.3 $\pm$ 0.15
	Color	Any Color

### Marking :

YUNG LI (UL) E241374 SJT 3/C 14AWG(2.08mm<sup>2</sup>) 105°C 300V VW-1  
 CSA 177323 SJT 3/C 14AWG(2.08mm<sup>2</sup>) 105°C 300V FT2

# YUNG LI CO., LTD

## SPECIFICATION

Yung-Li	Style	PVC FLEXIBLE CORDS	Document No
2017.09.28			
Edition	Size	<b>SJT 14/ 3C 105°C</b>	Page
A			2/2

3. Electrical & Physical Properties			
Item		Specification	
Rating Voltage		300V	
Insulation Resistance		$\geq 0.76\text{M}\Omega/\text{Km}$ 15.0°C Min	
Dielectric Strength		AC 2.0KV/1 min No Crack	
Spark Test		6.0KV/0.15 Sec	
Insulation	Unaged	Tensile Strength	1500 lbs/in <sup>2</sup> min
		Elongation	100%Min
	Aged	Tensile Strength	Min 85%(136±1°C x168hrs)
		Elongation	Min 65%(136±1°C x168hrs)
Jacket	Unaged	Tensile Strength	1500 lbs/in <sup>2</sup> min
		Elongation	100%Min
	Aged	Tensile Strength	Min 85%(136±1°C x168hrs)
		Elongation	Min 45%(136±1°C x168hrs)
Deformation Test		121±1°C m X 1hr $\leq 50\%$	
Cold Bend Test		-20°C x 4hr No Crack	
Heat Shock Test		121±1°C x 1hr No Crack	

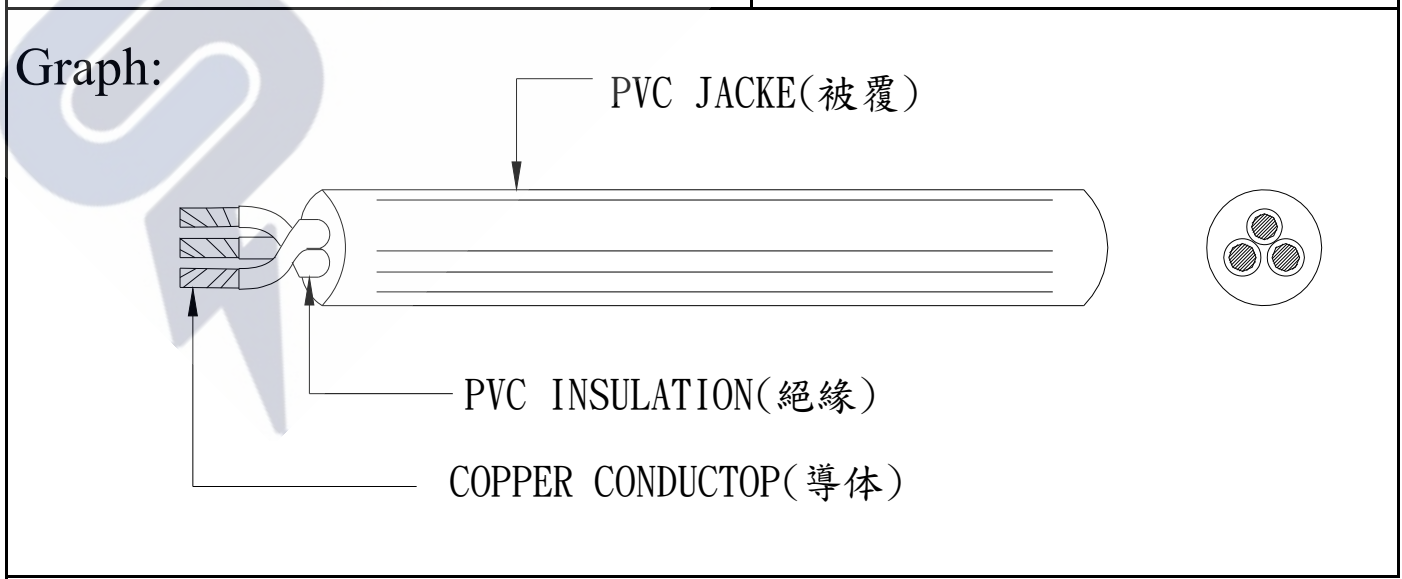

# ELBZ7.E152635 - Cord Sets and Power-supply Cords Certified for Canada

## Cord Sets and Power-supply Cords Certified for Canada

See General Information for Cord Sets and Power-supply Cords Certified for Canada

### YUNG LI CO LTD

7F-12 NO 99 SEC 1 XINTAI 5TH RD  
XIZHI DISTRICT  
NEW TAIPEI, 22175 TAIWAN

### Power-supply cords

E152635

Cat. No.	ANSI/NEMA WD6 Config	Cord AWG	Cord Type	Electrical Rating Amps V
YP-11	1-15	18/2	SPT-1, SPT-2, SPT-3, NISPT-2, SVT, SVTO, SJT, SJTW, SJTO, SJTOW (All TPE material), SPT-1, SPT-1W, NISPT-1, SPT-2, SPT-2W, NISPT-2, SPT-3, HPN, SVT, SVTO, SJT, SJTW, SJTO, SJTOW, SV, SVO, SJ, SJO, SJOW, SJOOW, EVT, EVJT, EVE, EVJE	7 or 10/125
		17/2	SVT, SVTO (All TPE material), SVT, SVTO, SV, SVO, SJ, SJO, SJOW, SJOOW, EVT, EVJT, EVE, EVJE	12/125
		16/2	SPT-2, SPT-3, NISPT-2, SVT, SVTO, SJT, SJTW, SJTO, SJTOW (All TPE material), SPT-2, SPT-2W, NISPT-2, SPT-3, SVT, SVTO, SJT, SJTW, SJTO, SJTOW, SV, SVO, SJ, SJO, SJOW, SJOOW, EVT, EVJT, EVE, EVJE	13/125
		16/2	HPN	15/125
		14/2	SPT-3, SJT, SJTW, SJTO, SJTOW (All TPE material), SPT-3, SJT, SJTW, SJTO, SJTOW, SJ, SJO, SJOW, SJOOW, EVT, EVJT, EVE, EVJE	15/125
YP-11W	1-15P	18/2	SPT-1, SPT-2, SPT-3, NISPT-2, SVT, SVTO, SJT, SJTW, SJTO, SJTOW (All TPE material), SPT-1, SPT-1W, NISPT-1, SPT-2, SPT-2W, NISPT-2, SPT-3, HPN, SVT, SVTO, SJT, SJTW, , SJTO, SJTOW, SV, SVO, SJ, SJO, SJOW, SJOOW, EVT, EVJT, EVE, EVJE	7 or 10/125
		17/2	SVT, SVTO (All TPE material), SVT, SVTO, SV, SVO, SJ, SJO, SJOW, SJOOW, EVT, EVJT, EVE, EVJE	12/125
		16/2	SPT-2, SPT-3, NISPT-2, SVT, SVTO, SJT, SJTW, SJTO, SJTOW (All TPE material), SPT-2, SPT-2W, NISPT-2, SPT-3, SVT, SVTO, SJT, SJTW, SJTO, SJTOW, SV, SVO, SJ, SJO, SJOW, SJOOW, EVT, EVJT, EVE, EVJE	13/125
		16/2	HPN	15/125
		14/2	SPT-3, SJT, SJTW, SJTO, SJTOW (All TPE material), SPT-3, SJT, SJTW, SJTO, SJTOW, SJ, SJO, SJOW, SJOOW, EVT, EVJT, EVE, EVJE	15/125



		14/3	SJT, SJTW, SJTO, SJTOW, ST, STW, STOW, SPT-3 (All TPE material), SJT, SJTW, SJTO, SJTOW, ST, STW, STOW, SO, SOW, SOOW, SPT-3, EVT, EVJT, EVE, EVJE	15/250
		12/3	SJT, SJTW, SJTO, SJTOW, ST, STW, STOW, SPT-3 (All TPE material), SJT, SJTW, SJTO, SJTOW, ST, STW, STOW, SO, SOW, SOOW, SPT-3, EVT, EVJT, EVE, EVJE	15/250
YP-31	IEC C8	18/2	SVT, SVTO, SJT, SJTW, SJTO, SJTOW, SPT-1, SPT-2, NISPT-2 (All TPE material), SVT, SVTO, SJT, SJTW, SJTO, SJTOW, SV, SVO, SJ, SJO, SJOW, SJOOW, SPT-1, SPT-1W, SPT-2, SPT-2W, NISPT-1, NISPT-2, EVT, EVJT, EVE, EVJE	7/125, 2.5/250
YP-32, YP-32L, YP-32L-1, YP-32L-2, YP-32L-3	IEC C14	18/3	SVT, SJT, SJTW, SJTO, SJTOW, ST, STW, STOW (All TPE material, Shielded and Non-shielded for all types), SVT, SJT, SJTW, SJTO, SJTOW, ST, STW, STOW, SJ, SJO, SJO, SJOW, SJOOW, SO, SOO, SOW, SOOW (Shielded or Non-shielded for all types), EVT, EVJT, EVE, EVJE	2.5, 7 or 10/125 or 250
		17/3	SVT, SJT, SJTW, SJTO, SJTOW, ST, STW, STOW (All TPE material, Shielded and Non-shielded for all types), SVT, SJT, SJTW, SJTO, SJTOW, ST, STW, STOW, SJ, SJO, SJO, SJOW, SJOOW, SO, SOO, SOW, SOOW (Shielded or Non-shielded for all types), EVT, EVJT, EVE, EVJE	10, 12/125 or 250
		16/3	SJT, SJTW, SJTO, SJTOW, ST, STW, STOW (All TPE material, Shielded and Non-shielded for all types), SJT, SJTW, SJTO, SJTOW, ST, STW, STOW, SJ, SJO, SJO, SJOW, SJOOW, SO, SOO, SOW, SOOW (Shielded or Non-shielded for all types), EVT, EVJT, EVE, EVJE	13/125 or 250
		15/3	SJT, SJTW, SJTO, SJTOW, ST, STW, STOW (All TPE material, Shielded and Non-shielded for all types), SJT, SJTW, SJTO, SJTOW, ST, STW, STOW, SJ, SJO, SJO, SJOW, SJOOW, SO, SOO, SOW, SOOW (Shielded or Non-shielded for all types), EVT, EVJT, EVE, EVJE	14/125 or 250
		14/3	SJT, SJTW, SJTO, SJTOW, ST, STW, STOW (All TPE material, Shielded and Non-shielded for all types), SJT, SJTW, SJTO, SJTOW, ST, STW, STOW, SJ, SJO, SJO, SJOW, SJOOW, SO, SOO, SOW, SOOW (Shielded or Non-shielded for all types), EVT, EVJT, EVE, EVJE	15/125 or 250
YP-12D	5-15	18/3	SVT, SJT, SJT Shielded, SJTW, SJTO, SJTOW (All TPE material), SVT, SJT, SJT Shielded, SJTW, SJTO, SJTOW, EVT, EVJT, EVE, EVJE	7 or 10/125
		16/3	SVT, SJT, SJT Shielded, SJTW, SJTO, SJTOW (All TPE material), SVT, SJT, SJT Shielded, SJTW, SJTO, SJTOW, EVT, EVJT, EVE, EVJE	13/125
		14/3	SVT, SJT, SJT Shielded, SJTW, SJTO, SJTOW (All TPE material), SVT, SJT, SJT Shielded, SJTW, SJTO, SJTOW, EVT, EVJT, EVE, EVJE	15/125
YP-32A	IEC C14	18/3	SVT, SJT, SJT Shielded, SJTW, SJTO, SJTOW (All TPE material), SVT, SJT, SJT Shielded, SJTW, SJTO, SJTOW, EVT, EVJT, EVE, EVJE	2.5, 7 or 10/250
		16/3	SVT, SJT, SJT Shielded, SJTW, SJTO, SJTOW (All TPE material), SVT, SJT, SJT Shielded, SJTW, SJTO, SJTOW, EVT, EVJT, EVE, EVJE	13/250



		15	SJT, SJTW, SJTO, SJTOW, SJTOOW, ST, STW, STOW, STOOW, SPT-3 (All TPE material), SJT, SJTW, SJTO, SJTOW, SJTOOW, SJ, SJO, SJOO, SJOW, SJOOW, ST, STW, STOW, STOOW, S, SO, SOW, SOO, SOOW, SPT-3	16/125 or 250
		14	SJT, SJTW, SJTO, SJTOW, SJTOOW, ST, STW, STOW, STOOW, SPT-3 (All TPE material), SJT, SJTW, SJTO, SJTOW, SJTOOW, SJ, SJO, SJOO, SJOW, SJOOW, ST, STW, STOW, STOOW, S, SO, SOW, SOO, SOOW, SPT-3	16/125 or 250
		12	SJT, SJTW, SJTO, SJTOW, SJTOOW, ST, STW, STOW, STOOW, SPT-3 (All TPE material), SJT, SJTW, SJTO, SJTOW, SJTOOW, SJ, SJO, SJOO, SJOW, SJOOW, ST, STW, STOW, STOOW, S, SO, SOW, SOO, SOOW, SPT-3	20/125 or 250 V ac
YC-18L	IEC C19	16	SJT, SJTW, SJTO, SJTOW, SJTOOW, ST, STW, STOW, STOOW, SPT-3 (All TPE material), SJT, SJTW, SJTO, SJTOW, SJTOOW, SJ, SJO, SJOO, SJOW, SJOOW, ST, STW, STOW, STOOW, S, SO, SOW, SOO, SOOW, SPT-3	13/125 or 250 V ac
		15	SJT, SJTW, SJTO, SJTOW, SJTOOW, ST, STW, STOW, STOOW, SPT-3 (All TPE material), SJT, SJTW, SJTO, SJTOW, SJTOOW, SJ, SJO, SJOO, SJOW, SJOOW, ST, STW, STOW, STOOW, S, SO, SOW, SOO, SOOW, SPT-3	250 V ac
		14	SJT, SJTW, SJTO, SJTOW, SJTOOW, ST, STW, STOW, STOOW, SPT-3 (All TPE material), SJT, SJTW, SJTO, SJTOW, SJTOOW, SJ, SJO, SJOO, SJOW, SJOOW, ST, STW, STOW, STOOW, S, SO, SOW, SOO, SOOW, SPT-3	16/125 or 250 V ac
		12	SJT, SJTW, SJTO, SJTOW, SJTOOW, ST, STW, STOW, STOOW, SPT-3 (All TPE material), SJT, SJTW, SJTO, SJTOW, SJTOOW, SJ, SJO, SJOO, SJOW, SJOOW, ST, STW, STOW, STOOW, S, SO, SOW, SOO, SOOW, SPT-3	20/125 or 250 V ac
YC-20	IEC C15	18	SVT, SJT, SJTW, SJTO, SJTOW, ST, STW, STOW, SPT-3 (All TPE material), SVT, SJT, SJTW, SJTO, SJTOW, ST, STW, STOW, SO, SOW, SOOW, SPT-3	2.5, 7 or 10/125 or 250
		17	SVT, SJT, SJTW, SJTO, SJTOW, ST, STW, STOW, SPT-3 (All TPE material), SVT, SJT, SJTW, SJTO, SJTOW, ST, STW, STOW, SO, SOW, SOOW, SPT-3	12/125 or 250
		16	SJT, SJTW, SJTO, SJTOW, ST, STW, STOW, SPT-3 (All TPE material), SJT, SJTW, SJTO, SJTOW, ST, STW, STOW, SO, SOW, SOOW, SPT-3	13/125 or 250
		15	SJT, SJTW, SJTO, SJTOW, ST, STW, STOW, SPT-3 (All TPE material), SJT, SJTW, SJTO, SJTOW, ST, STW, STOW, SO, SOW, SOOW, SPT-3	14/125 or 250
		14	SJT, SJTW, SJTO, SJTOW, ST, STW, STOW, SPT-3 (All TPE material), SJT, SJTW, SJTO, SJTOW, ST, STW, STOW, SO, SOW, SOOW	15/125 or 250
YC-25	IEC C21	16	SJT, SJTW, SJTO, SJTOW, SJTOOW, ST, STW, STOW, STOOW, SPT-3 (All TPE material), SJT, SJTW, SJTO, SJTOW, SJTOOW, SJ, SJO, SJOO, SJOW, SJOOW, ST, STW, STOW, STOOW, S, SO, SOW, SOO, SOOW, SPT-3	13/125 or 250
		15	SJT, SJTW, SJTO, SJTOW, SJTOOW, ST, STW, STOW, STOOW, SPT-3 (All TPE material), SJT, SJTW, SJTO, SJTOW, SJTOOW, SJ, SJO, SJOO, SJOW, SJOOW, ST, STW, STOW, STOOW, S, SO, SOW, SOO, SOOW, SPT-3	16/125 or 250
		14	SJT, SJTW, SJTO, SJTOW, SJTOOW, ST, STW, STOW, STOOW, SPT-3 (All TPE material), SJT, SJTW, SJTO, SJTOW, SJTOOW, SJ, SJO, SJOO, SJOW, SJOOW, ST, STW, STOW, STOOW, S, SO, SOW, SOO, SOOW, SPT-3	16/125 or 250
		12	SJT, SJTW, SJTO, SJTOW, SJTOOW, ST, STW, STOW, STOOW, SPT-3 (All TPE material), SJT, SJTW, SJTO, SJTOW, SJTOOW, SJ, SJO, SJOO, SJOW, SJOOW, ST, STW, STOW, STOOW, S, SO, SOW, SOO, SOOW, SPT-3	20/125 or 250
YC-25L	IEC C21	16	SJT, SJTW, SJTO, SJTOW, SJTOOW, ST, STW, STOW, STOOW, SPT-3 (All TPE material), SJT, SJTW, SJTO, SJTOW, SJTOOW, SJ, SJO, SJOO, SJOW, SJOOW, ST, STW, STOW, STOOW, S, SO, SOW, SOO, SOOW, SPT-3	13/125 or 250 V ac



# Certificate of Compliance

**Certificate:** 70206738

**Master Contract:** 177323 (076393)

**Project:** 70206738

**Date Issued:** 2019-03-19

**Issued to:** Yung Li Company Ltd.  
7F-12, NO.99, Sec.1  
Xintai 5th Rd., Xizhi Dist  
New Taipei City, 22175  
TAIWAN  
**Attention:** W.T. Lai

*The products listed below are eligible to bear the CSA Mark shown*



**Issued by:** Wenwen (Vivian) Zhao  
Wenwen (Vivian) Zhao

## PRODUCTS

CLASS - C584202 - CORD SETS-Power Supply Cords

Power supply cord(s) consisting of the following plug connector or cord connector moulded onto flexible cords as listed:

Power Supply Cord		Flexible Cord		
Cat No	Configuration	AWG	Rating	Type
YC-12, YC-12L	Connector 60320 C13	18/3	10 A, 125/250 V	SPT-2, SPT-3, SVT(S&U), SJT(S&U), SJTW(S&U), SJTO(S&U), SJTOW(S&U), SJ(S&U), SJO(S&U), SJO(S&U), SJOW(S&U), SJOOW(S&U), ST(S&U), STW(S&U), STOW(S&U)d, SO(S&U), SOO(S&U), SOW(S&U), SOOW(S&U)
		16/3	13 A, 125/250 V	SPT-3, SJT(S&U), SJTW(S&U), SJTO(S&U), SJTOW(S&U), SJ(S&U), SJO(S&U), SJO(S&U), SJOW(S&U), SJOOW(S&U), ST(S&U), STW(S&U), STOW(S&U)d, SO(S&U), SOO(S&U), SOW(S&U), SOOW(S&U)



**ZJCZ.E241374**  
**Flexible Cord**[Page Bottom](#)**Flexible Cord**[See General Information for Flexible Cord](#)**YUNG LI CO LTD**

E241374

7F-12 NO 99 SEC 1 XINTAI 5TH RD  
XIZHI DISTRICT  
NEW TAIPEI, 22175 TAIWAN

**Decorative cord**, Type(s) SPT-1W, SPT-2W**Dryer and range cord**, Type(s) SRDT**Jacketed cord**, Type(s) S, SE, SE-HF, SJ, SJE, SJE-HF, SJO, SJO, SJOOW, SJOW, SJJ, SJJ-B, SJTO, SJTOW, SJTW, SO, SOO, SOOW, SOW, ST, ST-B, STO, STOW, STW, SVE, SVE-HF, SVT, SVT-B, SVTO**Parallel cord**, Type(s) NISPE-1, NISPE-1-HF, NISPE-2, NISPE-2-HF, NISPT-1, NISPT-2, SPE-1, SPE-1-HF, SPE-2, SPE-2-HF, SPE-3, SPE-3-HF, SPT-1, SPT-2, SPT-3[Last Updated](#) on 2016-03-07[Questions?](#)[Print this page](#)[Terms of Use](#)[Page Top](#)

◆ 2016 UL LLC

The appearance of a company's name or product in this database does not in itself assure that products so identified have been manufactured under UL's Follow-Up Service. Only those products bearing the UL Mark should be considered to be Certified and covered under UL's Follow-Up Service. Always look for the Mark on the product.

UL permits the reproduction of the material contained in the Online Certification Directory subject to the following conditions: 1. The Guide Information, Assemblies, Constructions, Designs, Systems, and/or Certifications (files) must be presented in their entirety and in a non-misleading manner, without any manipulation of the data (or drawings). 2. The statement "Reprinted from the Online Certifications Directory with permission from UL" must appear adjacent to the extracted material. In addition, the reprinted material must include a copyright notice in the following format: "© 2016 UL LLC".



# Certificate of Compliance

**Certificate:** 1594794 (LL 76398)

**Master Contract:** 177323

**Project:** 2616524

**Date Issued:** April 3, 2013

**Issued to:** Yung Li Company Ltd.

1F No 10 Lane 235 Pao Chiao Rd  
Hsin Tien City  
Taipei Hsien,  
Taiwan  
Attention: Wendy Wu

*The products listed below are eligible to bear the CSA Mark shown*



*Kim Nguyen*

**Issued by:** Kim Nguyen, P. Eng.

## **PRODUCTS**

**CLASS 5831 01** - WIRES - Flexible Cord

Types SPT-1, NISPT-1, SPT-2, NISPT-2, SPT-3, SVT, SVTO, SJT, SJTW, SJTO, SJTOW, ST, STW, STO, STOW with PVC insulation and jacket, rated 60C, 75C, 90C and 105C, FT1, FT2, VW-1.

## **APPLICABLE REQUIREMENTS**

CSA C22.2 No 49 - Flexible Cords and Cables