

Twist-Lock® Devices  
 30A, 277V AC, 2 Pole, 3 Wire Grounding  
 Insulgrip® Flanged Inlet

# HUBBELL

## Features

- Backwired terminations for ease of installation
- #10-32 Multiple drive terminal screws (Slotted, Phillips, Robertson)
- Mounting screws included

## Ordering Information

Description	Device Color	UPC	Catalog Number
Nylon casing, back wired	White	783585038988	HBL2635

## Listings

Listed to UL 498  
 Fed.Spec. W-C-596  
 Certified to CSA C22.2 No.42

## Specifications

Housing / Flange	Nylon
Terminal Retainer	Clear polycarbonate
Blades	Brass
Terminal Screws	#10-32 Brass (Phillips / Slotted / Robertson)
Terminal Clamp	Cold rolled steel – nickel plated
Assembly Screws	Steel - nickel plated
Mounting Screw	Nickel plated brass

## Performance

Electrical	
Current Interrupting	Certified for current interrupting at full rated current
Dielectric Voltage	Withstands 2,000V minimum
Mechanical	
Cord Grip Accomodation	#16 AWG - #8 AWG solid or stranded copper wire only.
Terminal Identification	Terminals identified in accordance with UL 498
Environmental	
Flammability	HB or better per UL94/CSA 22.2 No.0.17
Moisture Resistance	IP20 Suitability
Operating Temperatures	Maximum Continuous 75°C. Minimum -40°C (w/o impact)

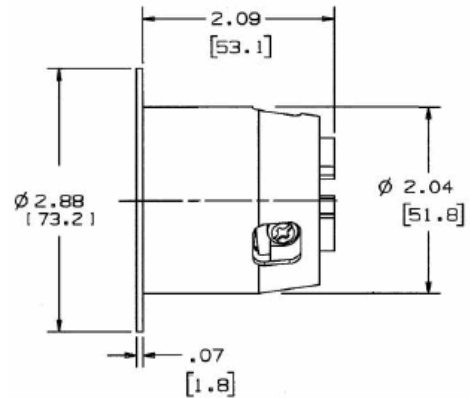

## Accessories

Connector	HBL2633
Weatherproof Lift Cover	WP2

## Resources

Customer Use Drawing  
 eCatalog

Dimensions in Inches (mm)

Hubbell Wiring Device-Kellems • Hubbell Incorporated (Delaware) • 40 Waterview Drive • Shelton, CT 06484

Phone (800) 288-6000 • Fax (800) 255-1031 • Specifications subject to change without notice.

