

REV	DATE	describe
D	2014.08.26	Plug increase the UL MARK, change the ampera from 16A to 15A for YC-18

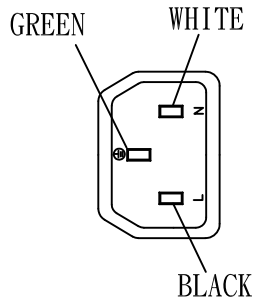

(180")4570±80



IEC 60320 C14

The Back Marking

YUNG LI
YP-32
15A 250V~

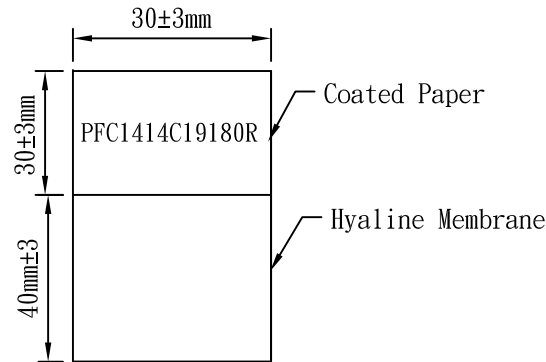
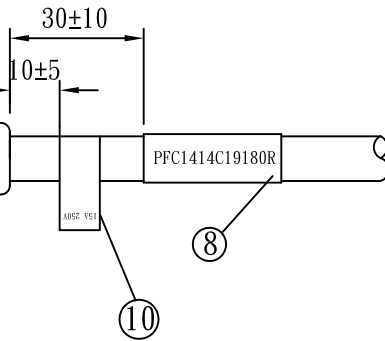

IEC 60320 C19

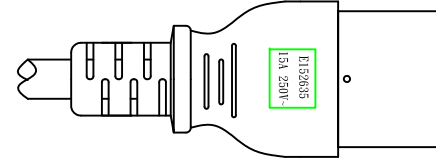
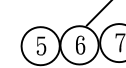
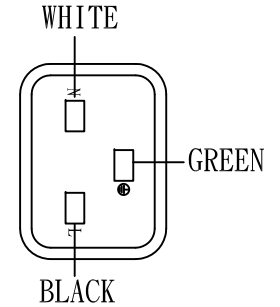

(16")400±30

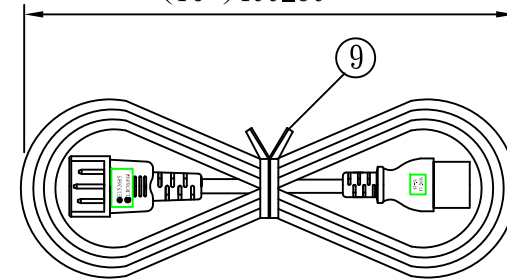

NO.	SPECIFICATION	Q' TY	REMARK
1	SJT 14/3C 105°C RED(GY-49)	1PC	
2	YP-32 PVC PLASTIC:35P RED(GY-49)	15g/PC	
3	TER:98672BS-1	3PCS	
4	INNER BODY: 2X4	1PC	
5	YC-18 PVC PLASTIC:50P RED(GY-49)	25g/PC	
6	YC-18 INNER BODY	1PC	
7	YC-18 TER:	3PCS	
8	LABEL: (40+30)*30mm	1PC	
9	MINI TIE:L=200mm WHITE	1PC	
10	LABEL:55*15mm	1PC	

Tolerance >0±0.30 >1.0±0.50 >10.0±1.0 >20.0±2.0 Angle: ±1°	Approved		Date		StayOnline®			
	Checked		Date					
	Drawn	SUKI	Date	14.08.26	Customer			
	Cat. No.	YP-32/YC-18			P/N.	PFC1414C19180R		
	Drawing No.	CY-U3942	Rev.	D	Material	P.V.C	Unit	mm
				Scale				