

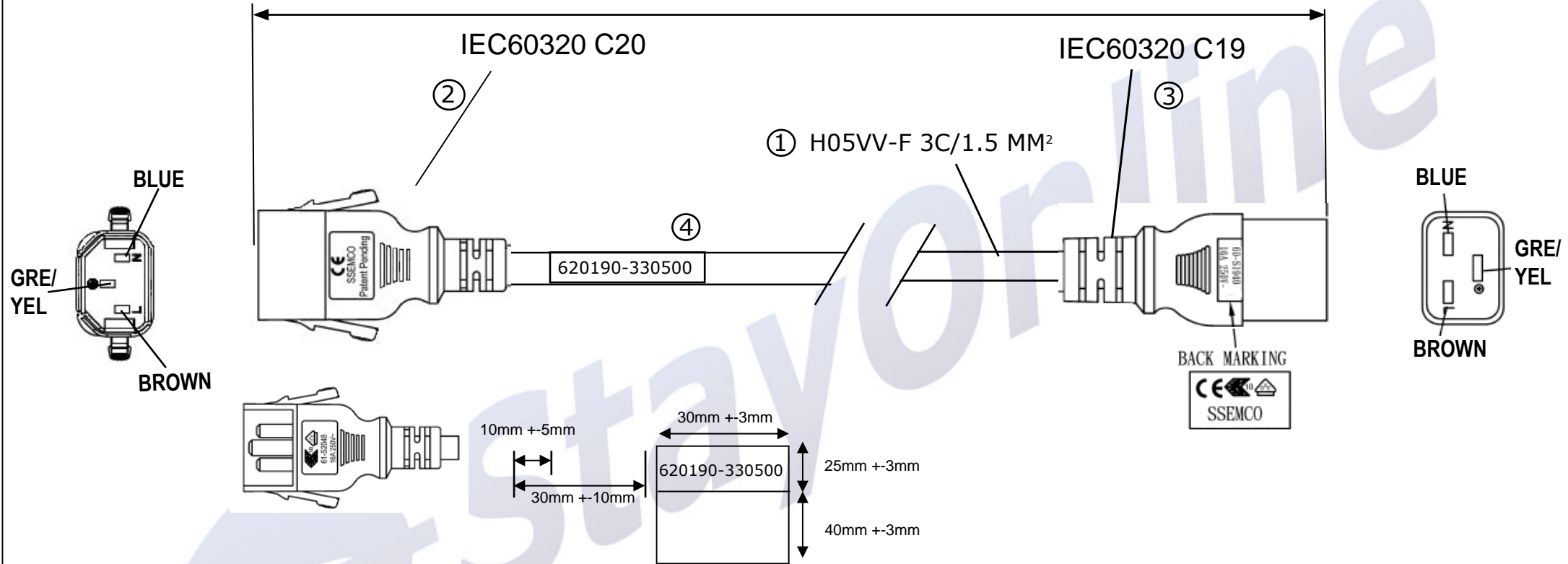

(20")500mm±50



NO.	SPECIFICATION	QTY	REMARK
1	H05VV-F 3C/1.5mm <sup>2</sup> 70°C BLACK	1 PC	
2	IEC60320 C20 LOCKING PLUG	1 PC	
3	IEC60320 C19 CONNECTOR	1 PC	
4	LABEL:(40+25)*30mm	1 PC	
5			
6			
7			
8			
9			
10			

Packing:  
 1. Bulk Pack.  
 2. Bundles of 10 Pieces.

Tolerance >0±0.30 >1.0±0.50 >10.0±1.0 >20.0±2.0 Angle: ±1°	Approved		Date		<b>StayOnline®</b>			
	Checked		Date					
	Drawn	TGD	Date	07/20/16	Customer			
	Cat. No.				P/N	620190-330500		
	Drawing No.	6534		Rev.		Material	P.V.C.	Unit
					Scale			