

You will not be informed separately if we change any marking or indication on cables according with approval organization's requirement!

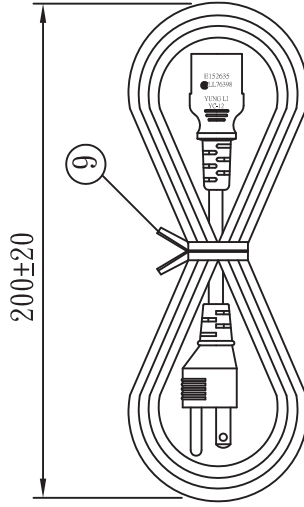

NO.	SPECIFICATION	Q'TY	REMARK
1	SVT 18/3C 105°C BLACK	1PC	
2	YP-12 PVC PLASTIC 35P BLACK	19g/PC	
3	TERMINAL: 98675BS-1/KDF 50T-2	2PCS	
4	∅ 4.75 TERMINAL: 98475	1PC	
5	YP-12 INNER BODY	1PC	
6	YC-12 PVC PLASTIC 35P BLACK	18g/PC	
7	U-TYPE TERMINAL: 97740	3PCS	
8	YC-12 INNER BODY	1PC	
9	MINI TIE: L=130mm BLACK	1PC	
10	LABEL: 55*15mm	1PC	

YUNG LI CO.,LTD			
Approved	Date	Customer	
Checked	Date	P/N.	
Drawn	Date	Material	
Cat. No.	YP-12/YC-12	Scale	
Drawing No.	CY-U0032	Rev.	B
Tolerance	>0±0.30		
	>1.0±0.50		
	>10.0±1.0		
	>20.0±2.0		
	Angle: ±1°		

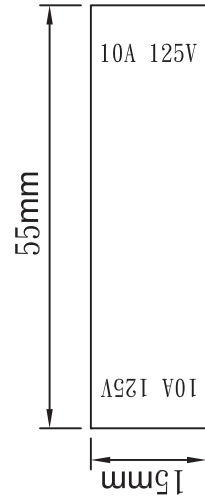
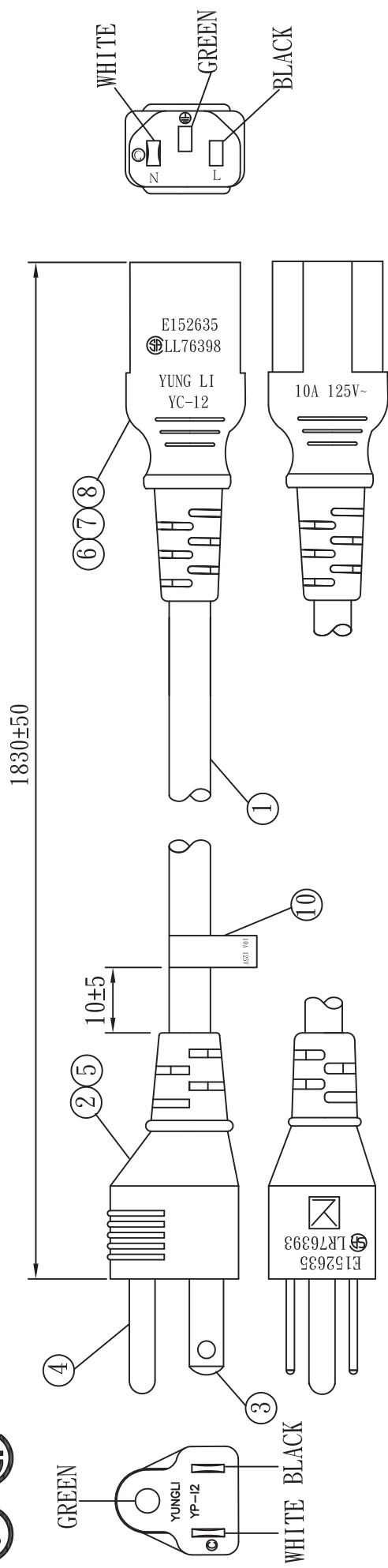
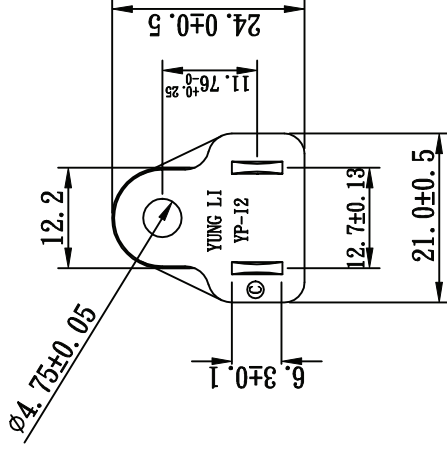
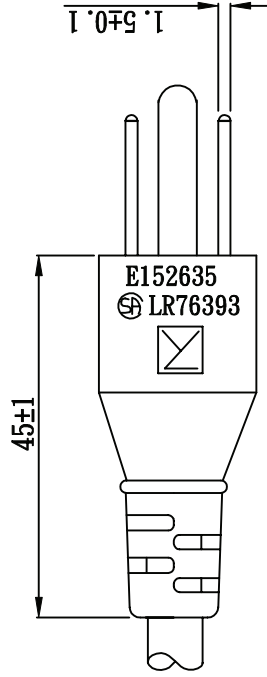
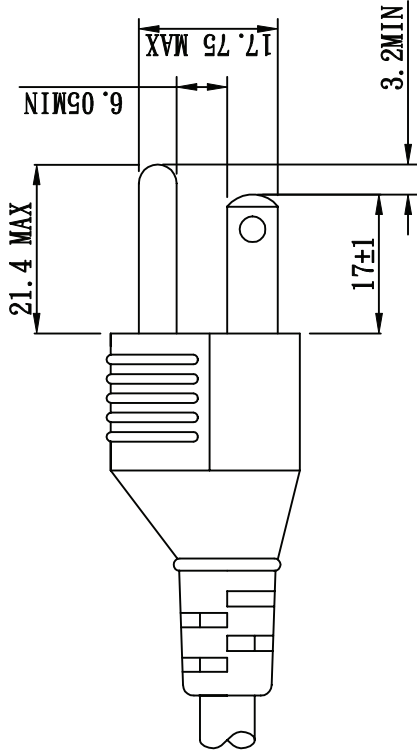

APPROVED		DATE	YUNG LI CO., LTD	
CHECKED		DATE	CUSTOMER	
DRAWN		DATE	P/N	
TYPE		YP-12		
P/N		MATERIAL		
DRAWING NO.		CY-P12U	REV	B
TOLERANCE		SCALE		
>0±0.30		1:1		
>1.0±0.50		UNIT		
>10.0±1.0		mm		
>20.0±2.0		P.V.C		
Angle:		1:1		
±1°		UNIT		
		mm		



IEC320-C13

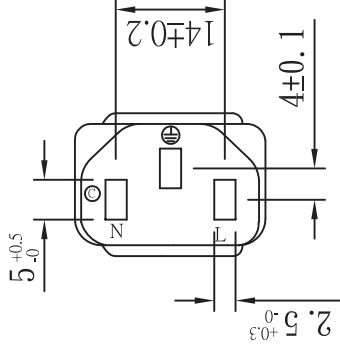
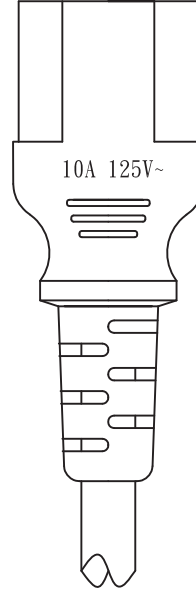
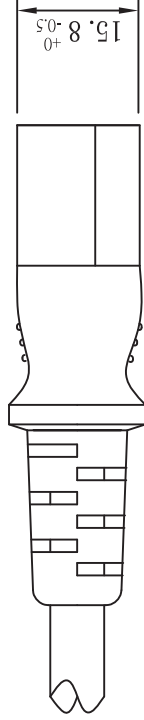
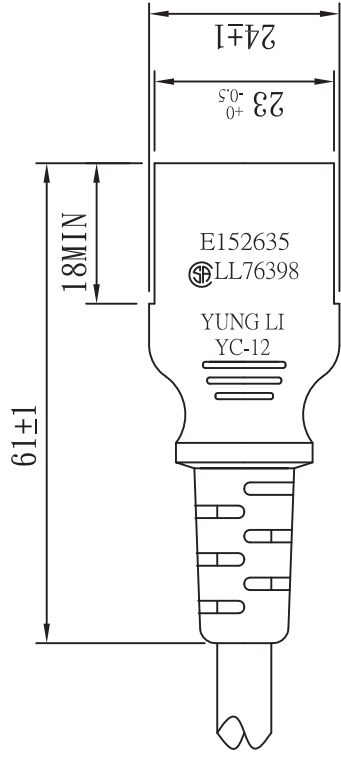

APPROVED	DATE	YUNG LI CO., LTD	
CHECKED	DATE	P/N	MATERIAL
DRAWN	DATE	P. V. C	UNIT
TYPE	YC-12	SCALE	1:1
DRAWING NO.	REV	B	mm
TOLERANCE $>0 \pm 0.30$ $>1.0 \pm 0.50$ $>10.0 \pm 1.0$ $>20.0 \pm 2.0$ Angle: $\pm 1^\circ$		SCALE	1:1

YUNG LI CO., LTD

SPECIFICATION

Yung-Li	Style	PVC FLEXIBLE CORDS	Document No
2007.5.03			
Edition	Size	SVT 18/ 3C 105°C	Page
A			1/2

1. Standard : UL 62 UL 1581

2. Construction & Dimension

	Item	Specification
Conductor	Size	18AWG x 3C
	Material	Annealed Bare Copper
	Construction	41/ ϕ 0.16±0.002
Insulation	Material	P.V.C.
	Minimum Average Thickness	0.38mm
	Minimum Thickness at any point	0.33mm
	Diameter	2.1 ± 0.1
	Identification	Black, Green, White
Core Assembly	Core Twist	3-Core
	Filler	Cotton 6000D
	Assembly Pair	NA
Taping	Mylar Foil	NA
Shielded	A1-Mylar Foil	NA
Drain Wire	Material	NA
	Construction	NA
Jacket	Material	PVC
	Minimum Average Thickness	0.76mm
	Minimum Thickness at any point	0.61mm
	Overall Diameter(Approx)	6.3 ± 0.15
	Color	Any Color

Marking :

**YUNG LI (UL) E241374 SVT 3/C 18AWG(0.824mm²) 105°C 300V
VW-1 CSA 177323 SVT 3/C 18AWG(0.824mm²) 105°C 300V FT2**

YUNG LI CO., LTD

SPECIFICATION

Yung-Li	Style	PVC FLEXIBLE CORDS	Document No
2007.5.03			
Edition	Size	SVT 18/ 3C 105°C	Page
A			2/2

3. Electrical & Physical Properties			
Item		Specification	
Rating Voltage		300V	
Insulation Resistance		$\geq 0.76\text{M}\Omega/\text{Km}$ 15.0°C Min	
Dielectric Strength		AC 1.5KV/1 min No Crack	
Spark Test		3.0KV/0.15 Sec	
Insulation	Unaged	Tensile Strength	1500 lbs/in2 min
		Elongation	100% Min
	Aged	Tensile Strength	Min 85% (136±1°C x 168hrs)
		Elongation	Min 65% (136±1°C x 168hrs)
Jacket	Unaged	Tensile Strength	1500 lbs/in2 min
		Elongation	100% Min
	Aged	Tensile Strength	Min 85% (136±1°C x 168hrs)
		Elongation	Min 45% (136±1°C x 168hrs)
Deformation Test		121°C±1°Cm X 1hr $\leq 50\%$	
Cold Bend Test		-20°C x 4hr No Crack	
Heat Shock Test		121°C±1°C x 1hr No Crack	
Flame Test		VW-1	

Graph:

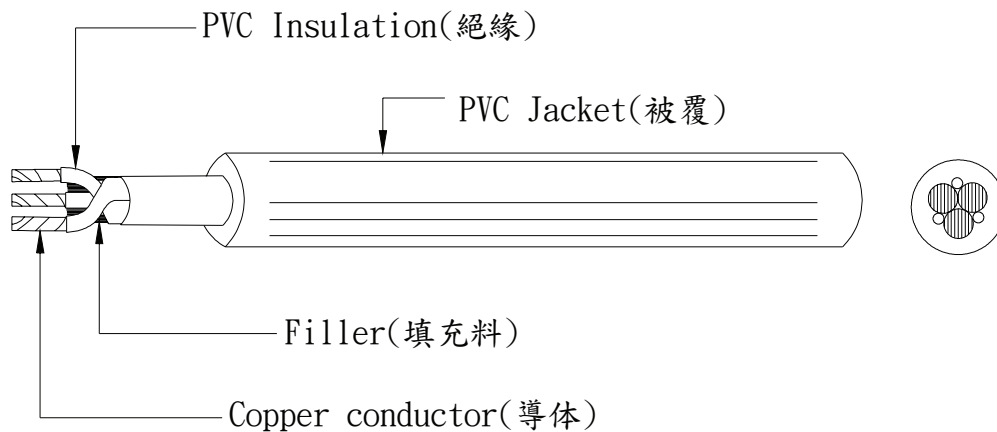

**ELBZ7.E152635****Cord Sets and Power-supply Cords Certified for Canada**

Page Bottom

Cord Sets and Power-supply Cords Certified for Canada

See General Information for Cord Sets and Power-supply Cords Certified for Canada

YUNG LI CO LTD

E152635

1ST FL

10 LANE 235 PAO-CHIAO RD

HSIN-TIEN, TAIPEI HSIEN 231 TAIWAN

Cord Sets — Power Supply Cords.

Cat. No.	Plug Cap Config	Flexible Cord Size (AWG)	Cord Type	Amps/Volts A/(V)ac
YP-11	1-15	18/2	SPT-1, SPT-1W, NISPT-1, SPT-2, SPT-2W, NISPT-2, SPT-3, HPN, SVT, SJT, SJTW, SJTO, SJTOW	10/125
		17/2	SVT	12/125
		16/2	SPT-2, SPT-2W, NISPT-2, SPT-3, SVT, SJT, SJTW, SJTO, SJTOW	13/125
		16/2	HPN	15/125
		14/2	SPT-3, SJT, SJTW, SJTO, SJTOW	15/125
YP-11W	1-15P	18/2	SPT-1, SPT-1W, NISPT-1, SPT-2, SPT-2W, NISPT-2, SPT-3, HPN, SVT, SJT, SJTW, , SJTO, SJTOW	10/125
		17/2	SVT	12/125
		16/2	SPT-2, SPT-2W, NISPT-2, SPT-3,SVT,SJT, SJTW, SJTO, SJTOW	13/125
		16/2	HPN	15/125
		14/2	SPT-3, SJT, SJTW, SJTO, SJTOW	15/125
YP-11C	1-15	18/2	NISPT-1, NISPT-2	10/125
YP-12	5-15	18/3	SVT, SVT Shielded, SJT, SJT Shielded, SJTW, SJTW Shielded, SJTO, SJTOW, ST, STW, STOW, SO, SOW, SOOW, SPT-2, SPT-3	10/125
		17/3	SVT	12/125
		16/3	SVT, SJT, SJTW, SJTO, SJTOW, ST, STW, STOW, SO, SOW, SOOW, SPT-2, SPT-3	13/125
		14/3	SJT, SJTW, SJTO, SJTOW, ST, STW, STOW, SO, SOW, SOOW, SPT-3	15/125
		12/3	SJT, SJTW, SJTO, SJTOW, ST, STW, STOW, SO, SOW, SOOW, SPT-3	15/125
YP-12L	5-15	18/3	SVT, SVT shielded, SJT, SJTW, SJTO, SJTOW, ST, STW, STOW, SO, SOW, SOOW, SPT-2, SPT-3	10/125
		16/3	SVT, SJT, SJTW, SJTO, SJTOW, ST, STW, STOW,	13/125

YP-12L-15, YP-12L-16, YP-12L-17, YP-12L-18		ST, STW, STO, STOW, STOO, STOOW, SJ, SJO, SJOW, SJOO, SJOOW, S, SO, SOW, SOO, SOOW, SPT-2, SPT-3	
	16/3	SVT, SVT Shielded, SJT, SJT Shielded, SJTW, SJTW Shielded, SJTO, SJTOW, SJTOO, SJTOOW, ST, STW, STO, STOW, STOO, STOOW, SJ, SJO, SJOW, SJOO, SJOOW, S, SO, SOW, SOO, SOOW, SPT-2, SPT-3	13/125
	14/3	SJT, SJT Shielded, SJTW, SJTW Shielded, SJTO, SJTOW, SJTOO, SJTOOW, ST, STW, STO, STOW, STOO, STOOW, SJ, SJO, SJOW, SJOO, SJOOW, S, SO, SOW, SOO, SOOW, SPT-3	15/125
	12/3	SJT, SJT Shielded, SJTW, SJTW Shielded, SJTO, SJTOW, SJTOO, SJTOOW, ST, STW, STO, STOW, STOO, STOOW, SJ, SJO, SJOW, SJOO, SJOOW, S, SO, SOW, SOO, SOOW, SPT-3	15/125

Cord Sets — Special Use Cord Sets.

Cat. No.	Cord Connector Configuration	Cord Type	Flexible Cord Size (AWG)	Voltage Rating V (ac)
YC-11	IEC C17	SPT-1, SPT-2, NISPT-1, NISPT-2, SPT-3, SVT, SJTO, SJTOW, ST, STW, STOW, SO, SOW, SOOW	18	125/250
		SPT-2, NISPT-2, SPT-3, SVT, SJT, SJTW, SJTO, SJTOW, ST, STW, STOW, SO, SOW, SOOW	16	125/250
YC-12, YC-12L	IEC C13	SVT, SVT Shielded, SJT, SJT Shielded, SJTW, SJTW Shielded, SJTO, SJTOW, ST, STW, STOW, SO, SOW, SOOW, SPT-2, SPT-3	18	125/250
	IEC C13	SJT, SJTW, SJTO, SJTOW, ST, STW, STOW, SO, SOW, SOOW, SPT-3	16	125/250
		SJT, SJTW, SJTO, SJTOW, ST, STW, STOW, SO, SOW, SOOW, SPT-3	14	125/250
YC-12 (A.C.1)	IEC C13	SJT, SJTW, SJTO, SJTOW, ST, STW, STOW, SO, SOW, SOOW, SPT-3	12	125/250
		SJT, SJTW, SJTO, SJTOW, ST, STW, STOW, SO, SOW, SOOW	10	125/250
YC-12C	IEC C13	NISPT-2	18	125/250
		NISPT-2	16	125/250
YC-13	IEC C7	SPT-1, SPT-1W, SPT-2, SPT-2W, NISPT-2, SVT, SJT	18	125
		NISPT-1		
YC-13W	IEC C7P	SPT-1, SPT-1W, SPT-2, SPT-2W, NISPT-2	18	125
YC-14	IEC C5	SVT, SVT Shielded	18	125
		SPT-2		
YC-13L	IEC C7	SPT-1, SPT-1W, SPT-2, SPT-2W	18	125
YC-13D	IEC C7	SPT-1, SPT-1W, SPT-2, SPT-2W, NISPT-1, NISPT-2, SJT, SVT	18	125
YC-13C	IEC C7	NISPT-1, NISPT-2	18	125
YC-14L	IEC C5	SVT, SJT, SPT-2	18	125
YC-18	IEC C19	SJT, SJTW, SJTO, SJTOW, ST, STW, STOW, SO, SOW, SOOW, SPT-3	14	250
		SJT, SJTW, SJTO, SJTOW, ST, STW, STOW	12	250 Vac
YC-18L	IEC C19	SJT, SJTW, SJTO, SJTOW, ST, STW, STOW, SJ, SJO, SJOO, SJOOW, S, SO, SOW, SOOW, SPT-3	16	125, 250 Vac



CERTIFICATION RECORD

The company named below has been authorized by CSA to represent the products listed in this record as "CSA Certified" and to affix the CSA Mark to these products according to the terms and conditions of the CSA Service Agreement and applicable CSA program requirements (including additional Markings).

File No: 076393 0 000

Class No: 5842 02 CORD SETS Power Supply Cords

SUBMITTOR

4554507 Yung Li Company Ltd.
1F No 10 Lane 235 Pao Chiao Rd
Hsin Tien City
Taipei Hsien,
Taiwan

FACTORY

4554507 Yung Li Company Ltd.
1F No 10 Lane 235 Pao Chiao Rd
Hsin Tien City
Taipei Hsien,
Taiwan

October 11, 2001(Replaces:April 23, 2001)

IN COMPLIANCE WITH CSA STD. C22.2 NO 21-95:

- Power supply cords consisting of the following plug caps moulded on flexible cords as indicated:

Cat No Plug Caps	Config- uration	Rating of PSC		AWG	Flexible Cord
		Amp	Volts		Type
YP-11, -11W	1-15P	10	125	18	SPT-1,-2, SVT, SPT-2 non-integral SPT-2, SVT, SPT-2 non-integral
		13	125	16	
YP-12, YP-12L	5-15P	10	125	18	SJT,SVT, SVT(Sh), SPT-2 SJT, SPT-2 SJT
		13	125	16/3	
		15	125	14/3	
YP-12A	5-15P	15	125	14/3	ST
YP-32	2p, 3W(Sp) (Sd)	10	125	18	SJT, SVT, SVT(Sh)



CERTIFICATION RECORD

The company named below has been authorized by CSA to represent the products listed in this record as "CSA Certified" and to affix the CSA Mark to these products according to the terms and conditions of the CSA Service Agreement and applicable CSA program requirements (including additional Markings).

File No: 076398 0 000

Class No: 5841 03 CORD SETS Special-use Cord Sets

SUBMITTOR

4554507 Yung Li Company Ltd.
1F No 10 Lane 235 Pao Chiao Rd
Hsin Tien City
Taipei Hsien,
Taiwan

FACTORY

4554507 Yung Li Company Ltd.
1F No 10 Lane 235 Pao Chiao Rd
Hsin Tien City
Taipei Hsien,
Taiwan

April 4, 2001(Replaces:March 14, 2001)

TO THE REQUIREMENTS OF CSA STD C22.2 NO. 21-95:

- Special-use cord sets consisting of the following connector bodies moulded onto any of the submittor's Certified power supply cords indicated:

Connector Body		Plug Cap		Flexible Cord	
Cat No/Config.	Rating	Cat No	Config	AWG	Type
YC-12/C13	10A, 125V	YP-12	5-15P	18/3	SJT, SVT, SVT (Sh)
	13A, 125V	YP-12	5-15P	16/3	SJT
	15A, 125V	YP-12	5-15P	14/3	SJT
	10A, 125V	YP-32 (Sd)	C14		SJT, SVT, SVT (Sh)
YC-13(N), YC-13L(N) /C7	10A, 125V	YP-11(N)	1-15P	18/2	SPT-1,-2, SPT-2 non-integral
YC-13W(P)/C7#	10A, 125V	YP-11W(P)	1-15P	18/2	SPT-1,-2, SPT-2 non-ingebral

The company named below has been authorized by CSA to represent the products listed in this record as "CSA Certified" and to affix the CSA Mark to these products according to the terms and conditions of the CSA Service Agreement and applicable CSA program requirements (including additional Markings).

File No: 076398 0 000

Class No: 5841 03 CORD SETS Special-use Cord Sets

SUBMITTOR

4554507 Yung Li Company Ltd.
1F No 10 Lane 235 Pao Chiao Rd
Hsin Tien City
Taipei Hsien,
Taiwan

FACTORY

4554507 Yung Li Company Ltd.
1F No 10 Lane 235 Pao Chiao Rd
Hsin Tien City
Taipei Hsien,
Taiwan

June 18, 2002(Replaces:June 7, 2002)

TO THE REQUIREMENTS OF CSA STD C22.2 NO. 21-95:

- Special-use cord sets consisting of the following connector bodies moulded onto any of the submittor's Certified power supply cords indicated:

Connector Body		Power Supply Cord			
Cat No.	Rating	Plug Cap Cat No	Config	Flexible Cord AWG	Type
YC-12(Sp23)	10A, 125V	YP-12	5-15P	18	SJT, SVT, SVT (Sh), SPT-2
	13A, 125V	YP-12	5-15P	16	SJT
	15A, 125V	YP-12	5-15P	14	SJT
	10A, 125V	YP-32 (Sd)	(SP23)	18	SJT, SVT, SVT (Sh)
YC-14(SP23)	10A, 125V	YP-12	5-15P	18	SJT, SVT, SPT-2

LEGEND: "(Sp23)" Special use, 2-pole, 3 wire grounding type; "(Sd)" Shrouded; "(Sh)" Shielded.

**ZJCZ.E241374
Flexible Cord**[Page Bottom](#)

Flexible Cord[See General Information for Flexible Cord](#)**YUNG LI CO LTD**

E241374

1ST FL

10 LANE 235 PAO-CHIAO RD

HSIN-TIEN, TAIPEI HSIEN 231 TAIWAN

Jacketed cords, Type SJTW, STW, SJTO, SJTOW, STO, STOW, SJ, S, SJO, SO, SVT, SVTO, SJT, ST, SJOW, SJOOW, SOW, SOOW, SJO, SOO.

Parallel cords, Type SPT-1, SPT-2, SPT-3, SPT-1W, SPT-2W, NISPT-1, NISPT-2.

Rang and dryer cord, Type SRDT.

[Last Updated on 2007-02-12](#)

[Questions?](#)[Notice of Disclaimer](#)[Page Top](#)[Copyright © 2007 Underwriters Laboratories Inc.®](#)

The appearance of a company's name or product in this database does not in itself assure that products so identified have been manufactured under UL's Follow-Up Service. Only those products bearing the UL Mark should be considered to be Listed and covered under UL's Follow-Up Service. Always look for the Mark on the product.

UL permits the reproduction of the material contained in the Online Certification Directory subject to the following conditions: 1. The Guide Information, Designs and/or Listings (files) must be presented in their entirety and in a non-misleading manner, without any manipulation of the data (or drawings). 2. The statement "Reprinted from the Online Certifications Directory with permission from Underwriters Laboratories Inc." must appear adjacent to the extracted material. In addition, the reprinted material must include a copyright notice in the following format: "Copyright © 2007 Underwriters Laboratories Inc.®"

An independent organization working for a safer world with integrity, precision and knowledge.





CSA INTERNATIONAL

Certificate of Compliance

Certificate: 1594794 (LL 76398)

Master Contract: 177323

Project: 2128031

Date Issued: 2009/03/03

Issued to: Yung Li Company Ltd.

1F No 10 Lane 235 Pao Chiao Rd
Hsin Tien City
Taipei Hsien,
Taiwan
Attention: Mr. W.T. Lai

The products listed below are eligible to bear the CSA Mark shown



Issued by: Kim Nguyen, P. Eng.

Authorized by: Nick Alfano, Operations
Manager

PRODUCTS

CLASS 5831 01 - WIRES - Flexible Cord

Types SPT-1, NISPT-1, SPT-2, NISPT-2, SPT-3, SVT, SVTO, SJT, SJTW, SJTO, SJTOW, ST, STW, STO, STOW with PVC insulation and jacket, rated 60C, 75C, 90C and 105C, FT1, FT2, VW-1.

APPLICABLE REQUIREMENTS

CSA C22.2 No 49 - Flexible Cords and Cables



CSA INTERNATIONAL

Supplement to Certificate of Compliance

Certificate: 1594794

Master Contract: 177323

The products listed, including the latest revision described below, are eligible to be marked in accordance with the referenced Certificate.

Product Certification History

Project	Date	Description
2128031	2009/03/03	Adding temperature ratings of 75C and 90C to Types SPT-1,-2,-3, NISPT-1,-2, SVT, SJT, SJTW, ST and STW.
1929621	2007/10/17	Types SJTO, SJTOW, STO, STOW, SVTO added.
1625068	2005/01/10	Addition of Flexible cords Types SJTW, STW rated 60C, 105C
1594794	2004/10/14	Original Certification: Flexible Cords SPT-1, -2, -3, NISPT-1, -2, SVT, SJT, ST