

Straight Blade Devices 20A, 125V, 2 Pole, 3 Wire Grounding Flanged Receptacles

HUBBELL

Features

- Impact resistant thermoplastic construction
- Backwired terminations for ease of installation
- #8-32 Multiple drive terminal screws
- Mounting screws included

Ordering Information

Description	Device Color	UPC	Catalog Number
Nylon casing, back wired.	White	783585174457	HBL5379C

Listings

UL Listed, File E2186
Certified to CSA, C22.2, No. 42
NEMA® WD-6 Compliant

Specifications

Housing	Nylon
Terminal Retainer	Clear polycarbonate
Contacts	Brass
Terminal Screws	#8-32 Brass, Multiple Drive
Terminal Clamp	Cold rolled steel – nickel plated
Assembly Screws	Steel - nickel plated
Mounting Screws	Nickel plated brass

Performance

Electrical	
Current Interrupting	Certified for current interrupting at full rated current
Dielectric Voltage	Withstands 2,000V minimum
Mechanical	
Product Identification	Ratings are a permanent part of the device
Terminal Accommodation	#18-#10 AWG copper stranded or solid conductor only
Terminal Identification	Terminals identified in accordance with UL 498 and CSA
Environmental	
Flammability	UL 94 V-2
Operating Temperatures	Maximum continuous 75°C; minimum -40°C (w/o impact)

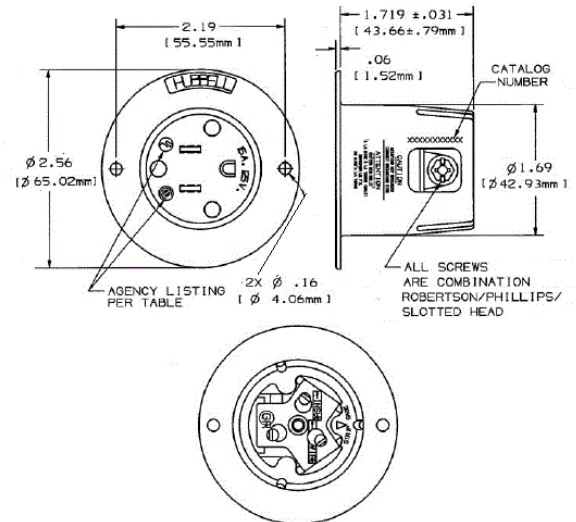

Accessories

Weatherproof Lift Cover	WP1
-------------------------	-----

Resources

Customer Use Drawing
eCatalog

Dimensions in Inches (mm)

Hubbell Wiring Device-Kellems • Hubbell Incorporated (Delaware) • 40 Waterview Drive • Shelton, CT 06484

Phone (800) 288-6000 • Fax (800) 255-1031 • Specifications subject to change without notice.

